



CYPETHERM HVAC

CYPETHERM HVAC is a program created to design HVAC installations (heating, ventilation and air conditioning).

This application is integrated in the Open BIM workflow using the IFC standard.

INDEX

- Analysis methodology and standards
- Workspace
 - Building
 - Flow diagrams
 - Floor plans
 - Systems
- Properties and results output
 - Checks
 - Design
 - Analysis results
- Inclusion in the Open BIM workflow
- User license

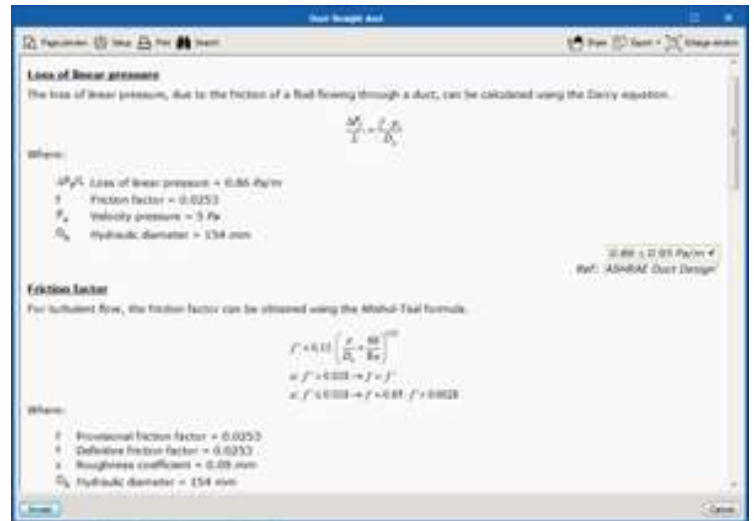

Analysis methodology and standards

The properties panel of each element contains the Consult results button. When pressed, the analysis method that has been applied appears.

The analysis methods have been performed in accordance with ASHRAE Standards.

Regarding radiant floors, the analysis and design of the systems are carried out in accordance with UNE-EN 1264.



Workspace

Building

The development of the installations is usually developed on the architecture of the building. The geometry of the building can be defined well by drawing the zones, using CAD templates, or by importing 3D geometry in IFC format.

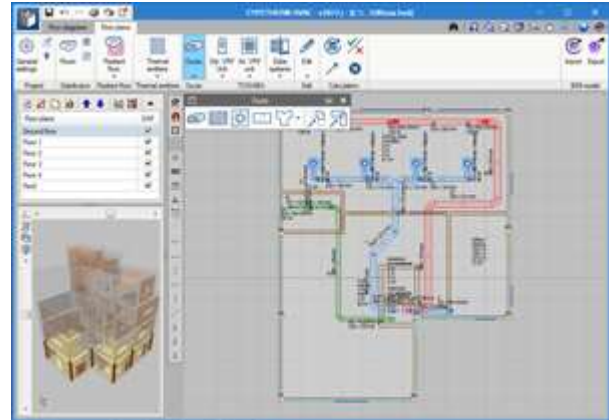

Flow diagrams

The elements required to create water or cooling fluid flow diagrams are available.

Regarding water flow diagrams, the program provides a graphical representation of boilers, coolers, heat pumps, air conditioners, expansion tanks, and all the associated valves. The symbols used are in accordance with ASHRAE Standard 134. The program designs the diameters of the pipes depending on the flow, temperature and selected materials library: ASME Standard B36.10 for water, ASME B88 for copper and ASTM Standard D3309 for polybutylene.

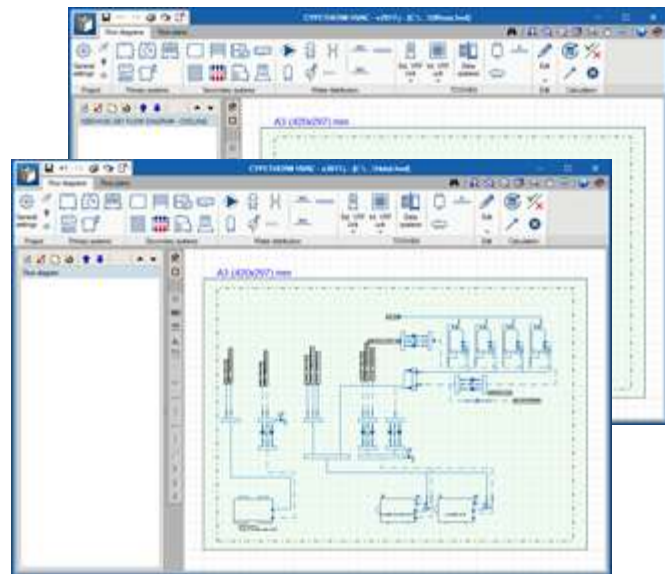

As for the refrigerant flow diagrams, **Toshiba VRF** systems can be introduced in the program, as heat pump or 3-pipe heat recovery systems. When the program performs the analysis, it checks all the maximum pipe lengths, elevation changes and working ranges, and are justified with a report.

Floor plans

The elements that will be physically located in the zone to be conditioned are defined in the Floor plans tab. The elements are represented in real size.

Systems

- **Radiant floor.** The implemented radiant floor systems are: types A, B and C described in the UNE-EN 1264 code. The program offers different tools such as the automatic generation and design of circuits, which make the program a quick and simple tool to use to design this type of building services.
- **Thermal emitters.** This section includes radiators, radiant panels, towel rails and electric emitters.
- **Variable refrigerant flow systems.** The 3 Toshiba ranges have been fully incorporated: the small, 2-pipe heat pump and 3-pipe heat recovery ranges.
- **Aerothermal system.** The aerothermal system is composed of an outdoor part, an indoor hydraulic unit that generates hot water and the option of an accumulator tank.
- **Air duct distribution.** Analysis and design of duct networks. Generation of fittings (elbows, duct transformations and branches) in accordance with ASHRAE. The program generates a report indicating the critical path and the accumulated pressure loss.

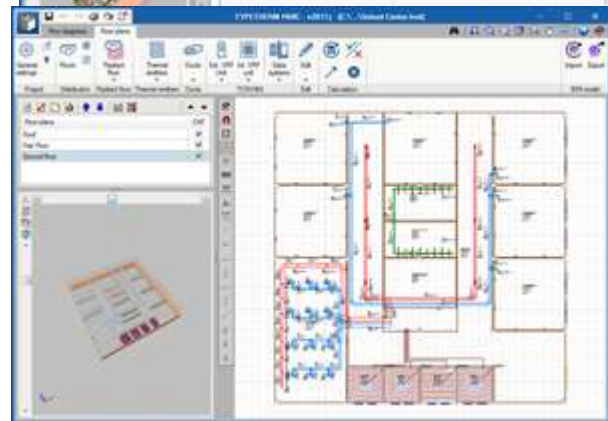
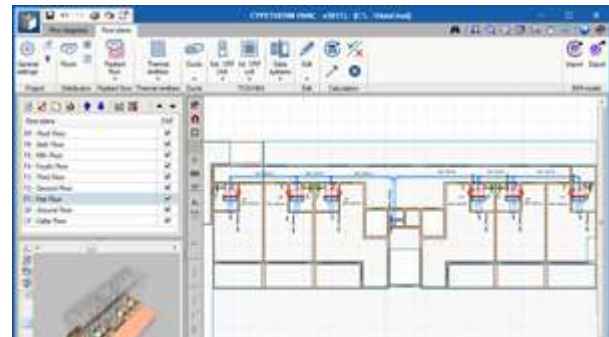
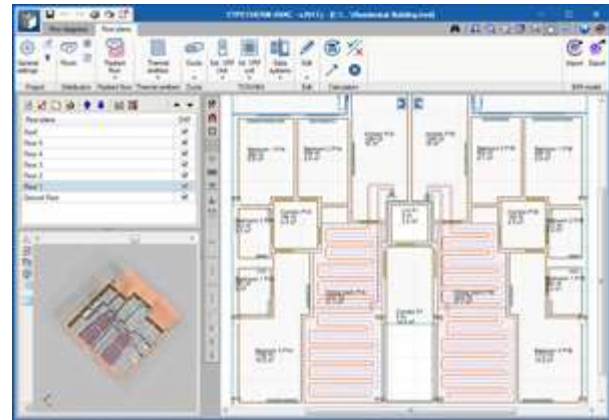

Properties and results output

Checks

The program checks if the parameters that have been introduced to design the installation lie within the criteria allowed by the implemented code and the ranges defined in the design options.

The result is a direct display of error or warning messages for elements which have failed checks and a detailed report when the design section of each element is accessed.

Design

The program also offers users the possibility to design the installation, i.e., the automatic size selection of the elements. To do so, the program takes the data defined in the library of each element and the thermal loads of the spaces (if any). Users can block the updating process of any data at any time using the blocking option.



Analysis results

These include:

- **Drawings** of the floor circuit and on plan distribution (PDF o DXF).
- **Analysis reports** and justification of the results obtained with their description.
- **Materials schedule** including their quantities, organised in chapters, of all the system elements.
- **Bill of quantities** with the description of the job items, quantities, subtotals and totals. Additionally, users can export the quantities to FIEBDC-3 (BC3) format.

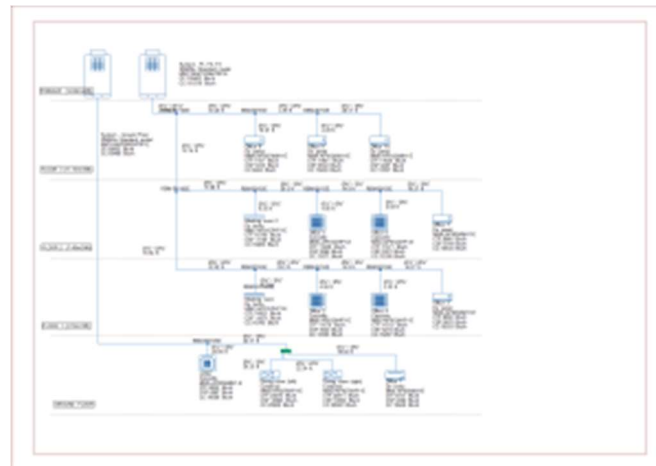

Inclusion in the Open BIM workflow

CYPETHERM HVAC is an application that can operate in an Open BIM project.

This implies it can be linked to a BIM directory, whether it be at a local folder or at the BIMserver.center, which will consist of a space containing several IFC files, all related to the same building.

There will always be an IFC file containing the geometry of the building which can be created using the free software, IFC Builder or any other software which exports to open standards.



The remaining IFC files are those corresponding to the building services of the building, such as lighting thermal loads, electricity, fire safety, etc.

The information shared amongst these systems will always flow in one direction: from the one responsible for the data to whichever requires the information.

Required user license permits

IFC Builder is a free CYPE application; no user license permits are required to use it.

For project consultancy and detailed information; cype@cype.ist or cype@cype.ae